

MC101 Catalytic Gas Sensor

MC101 operate on the catalytic combustion principle, and its two arms of electric bridge consists of a test element and a compensate element. The resistance of the test element rised when meeting the combustibile gas, in the same time, the output voltage of the bridge changed, the voltage variable is rised in direct proportion as the gas concentration, the compensate element as a reference, and compensate of temperaturer and humidity.



Feature

- *The bridge output in liner
- *Fast response
- *Good reproducibility and selectivity
- *Working steability
- *Excellent resistance of H2S、 silicon poisoning

Application

Application in gas concentration detection in industrial field such as natural gas, LPG, coal gas, alkane ect combustibile gas, and gasoline, Alcohol, ketone, benzene ect organic solvent;
 Combustibile gas leaking alarm or detectors;
 Gas concentration meter.

Specification

Type	MC101	
Series	Catalytic	
Standard cover	Plastic	
Working voltage(V)	3.0±0.1	
Working current(mA)	110±10	
Sensitivity(mV)	1% Methane	25~50
	1% Butane	30~50
	1% Hydrogen	25~45
Liner (%)	≤5	
Test range (%LEL)	0~100	
Response time (90%)	Less than 10s	
Recovery time (90%)	Less than 30s	
Working envirenment	-40—+70℃ less than 95%RH	
Storage	-20—+70℃ less than 95%RH	
Size (mm)	Φ12mm×8mm	

Configuration

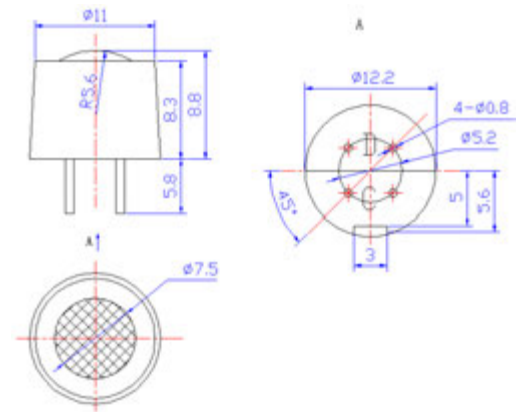

Basic testing circuit

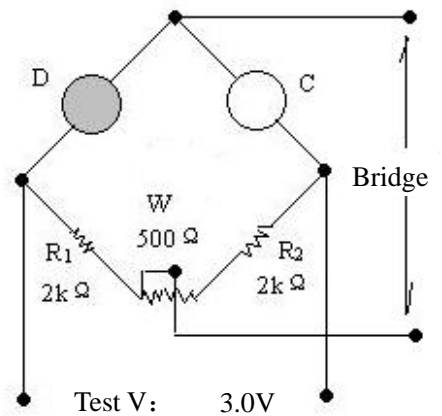

Sensitivity, response and recovery

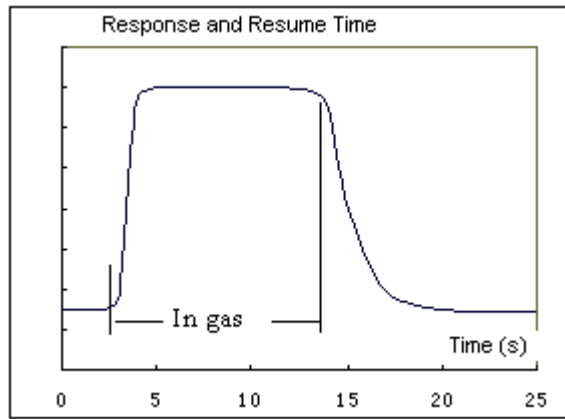
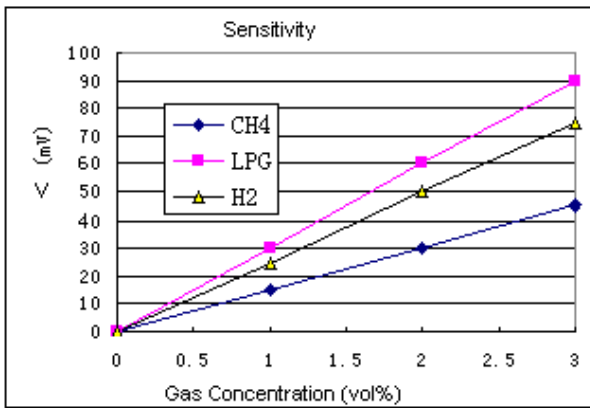

Output signal changed by Tem.

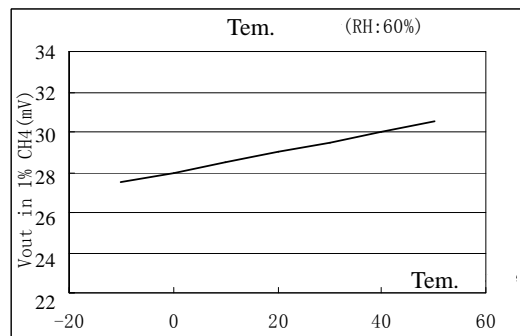
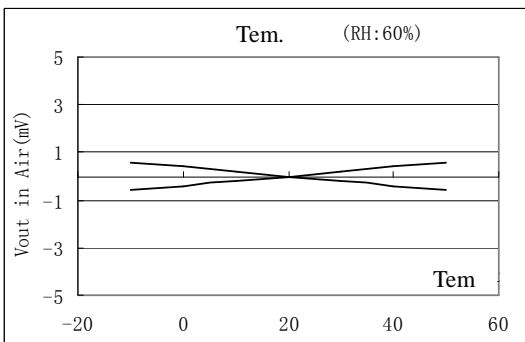

Output signal changed by Tem.

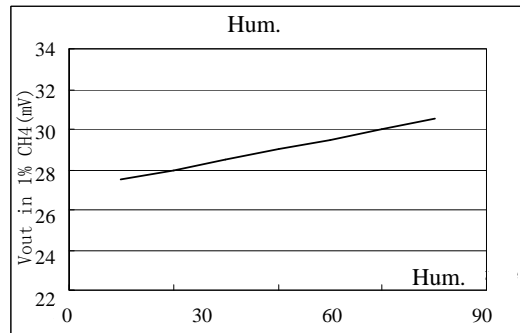
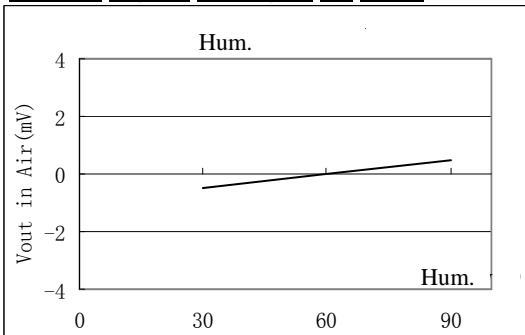

Output signal changed by voltage

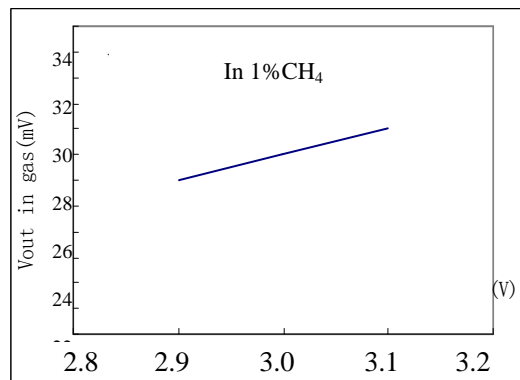
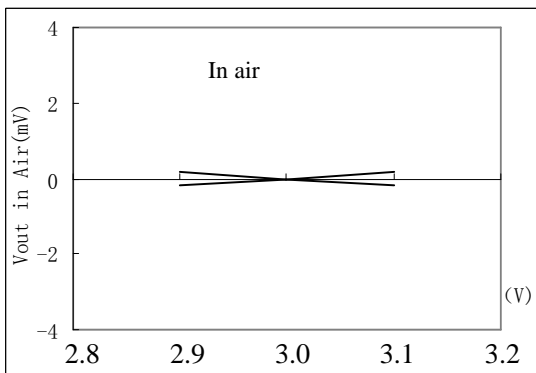

Long time stability

The drift in air per year is less than $\pm 2\text{mV}$, in $1\%\text{CH}_4$ is less than $\pm 2\text{mV}$. For a short period storage (in 2 weeks), the sensor need 30mins'preheating to stabilize. for more than one year storage, it need more than 5 hours peheating.

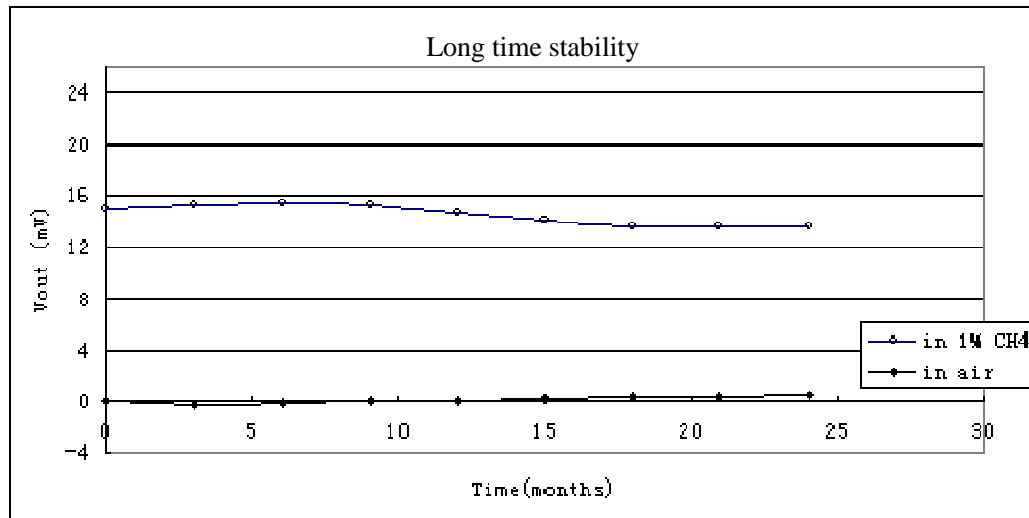

Notice

1 Must be avoid

1.1 Under the organic silicon

If the sensor face adsorb the organic silicon, its sensing elements will be wrapped, and restrained its sensitivity, also can not recover. The sensor must be avoid in the silicon, fixture, rubber, oily or other plastic additive of silicon.

1.2 Under the High causticity place

The sensor is under the high concentration causticity such as H_2S , SO_x , Cl_2 , HCl ect, it not only result the heating material and the sensor lead causticity or broken, but also changed the performance of the sensing material.

1.3 Pollution in alkali, alkali metal salt, halogen

The sensor performance reduced by the pollution of the alkali metal especially brine spray, and under the halogen such as Fluorin.

1.4 Meeting water

If spatter water or dip in the water, it will result of its sensitivity reduced.

1.5 Icing

If water icing on the sensor face, it will result that the sensing material smash and lose its sensitivity.

1.6 High voltage

If the voltage is higher than the value of the sensor or the heater, though the sensor is not broken, it will result that the lead or the heater broken, and make its sensitivity reduced.

2 Avoid as possible

2.1 Water coagulation

In the home, light coagulate water will impact the sensor performance not too much, but if the water coagulated on the face and for some time, the sensitivity will be reduced.

2.2 In the high concentration gas

Whether the sensor is electrify, the sensor stored in the high concentration gas for a long Time, it will impact its sensitivity.

2.3 Long time storage

The sensor is stored for a long time without electrify, its resistance will be drift ,
And this case is of the storage environment. The sensor must be storage in the seal bag without
Any silicon. The sensor is not electrified for storage, it must be electrify for a long time before using.
2.4 under the extremity place for a long time

Wether the sensor is electrify, under the extremity place for a long time such as high temperature,high
humidity, or high pollution ext, it will impact the sensor performance heavily.

2.5 Vabration

Vabration frequently or excessly, it will impact the sensor lead broken. And the vibration also will be
happened in the transportion or assembling or welding process.

2.6 Concussion

If the sensor is striked heavily, it will make the lead broken.

2.7 Using

It is better of weldling by hand for a sensor.

If you used the wave welding, please satisfied the conditions as below:

2.7.1 Welding assist: Include the least rosin

2.7.2 Speed:1-2m/munite

2.7.3 Preheating temperature:100±20°C

2.7.4 Welding temperature: 250±10°C

2.7.5 1time passed the machine

If you disobey the conditions, it will impact the sensor sensitivity.